

PTC Arbortext Content Delivery (Formerly InService™)

Trustworthy, contextual service documentation and parts information — anytime, anywhere.
Make it simple. Make it smart. Make it accessible.

PTC Arbortext Content Delivery is a powerful scalable foundation which provides a single web portal to access your content, regardless of where it is created or stored across your enterprise.

PTC Arbortext Content Delivery enables access to updated configuration-specific, documents, precision search, navigation and filtration pinpoint, with powerful bookmarking, interactive notes sharing and feedback capabilities, allowing the user to find the necessary high-quality information, right on time, boosting user productivity.

Arbortext Content Delivery provides rich “end-to-end” content enabling the highest quality formats with associativity back to Technical Publications. This holistic capability is a strong competitive differentiator for organizations that traditionally struggle with content focus, quality and accuracy limits inherent in disjointed approaches.

With a modern, adaptive and responsive user interface framework, Arbortext Content Delivery supports keyboard and touch-screen preferences across PCs and hand-held devices, providing access across the mobile workforce and customer base.



Technical Content at your fingertips

Key benefits

Rapid and efficient delivery of your content by:

- Publishing approved content directly from PTC Content Management, or 3rd party solutions
- Delivering technical and non-technical product documentation
- Including dynamic, interactive 3D and 2D illustrations that improve comprehension
- Ability to include your PDF legacy content with similar User-Experience
- Providing the same data updates to online and offline users

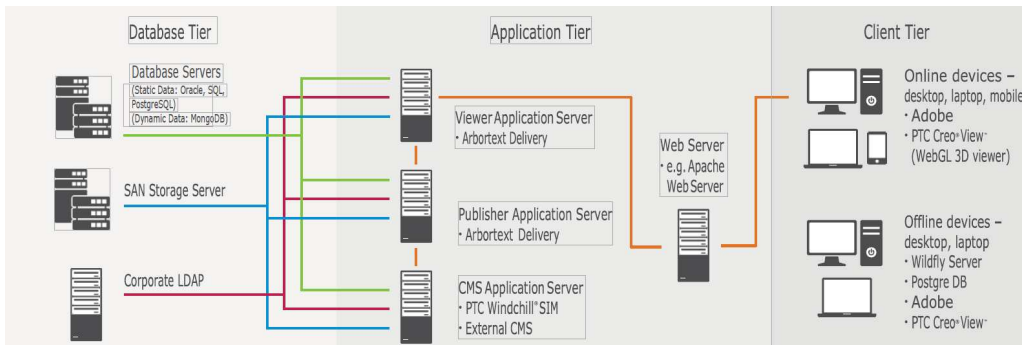

Enterprise class solution architecture

Improves end-user efficiency by:

- Shortening navigation and search time through a combination of intuitive textual and graphical navigation
- Selecting your content in your language of choice
- Ability to create document bookmarks
- Ability to personalize your content by adding or sharing notes on your content, for increased productivity
- Ability to print individual documents, or custom specific pdf books with navigation links
- Providing a feedback mechanism enabling a closed loop process for your technical pubs group

- Filter content by product instances, product attributes and effectivity dates
- Intelligent free text and advanced search with smart auto-suggest
- Bookmark your content or product
- Access your recently generated searches
- Create private or public notes on the content
- Create custom specific pdf books with navigation links
- Send Feedback on the content or functionality

Features

Ease-of-use

- Intuitive and easy-to-use web-based user interface
- Adaptive and responsive design
- Supporting multiple browsers and mobile platforms - IE, Chrome, Safari, iOS
- Leverage rich 2D/3D graphical illustration and PDFs on plugin-less environments (Chrome, iOS)
- Product-based navigation

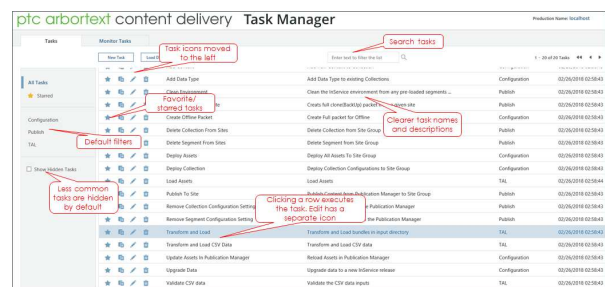

Highly scalable architecture

- Web-native architecture for ease of integration
- Parallel processing and loading
- Easy to setup and update the deployment configuration using intuitive high-end "Deployment Configurator" GUI, and out-of-the-box templates
- Synchronized deployment to multiple sites - clustered servers

- Support for clustering for large scale deployments
- Cloud compatible architecture
- Easy to deploy customization using Arbortext Content Delivery Installer framework
- Data and Software upgrades while maintaining 24x7 availability for the end-users

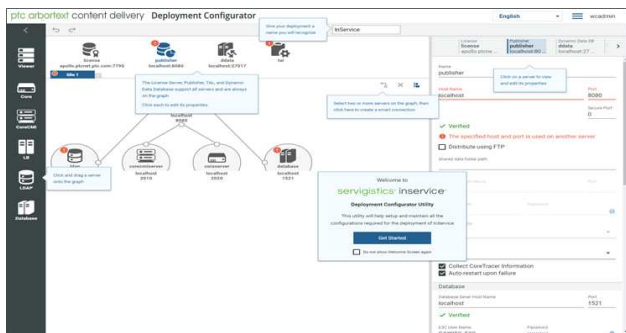

Deployment Configurator GUI

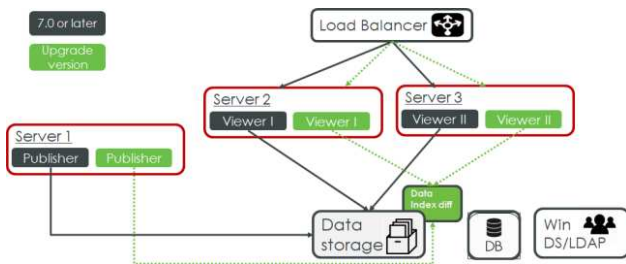

High availability architecture

End-2-End solution from publishing to delivery of technical content

- End-2-end compatibility with PTC and Arbortext applications suite: PTC Arbortext® Editor™, PTC Arbortext® Styler™, PTC Creo® Illustrate™, PTC Arbortext® IsoDraw™ and and PTC Arbortext® Publishing Engine™
- Content publishing module integrated with PTC Windchill® Service Information Manager™
- Scalable CSV loader for third-party content loading
- Incremental data loading to online and offline instances
- Various input format types – XML, PDF, MS Office formats (download only), 2D/3D graphics, multimedia files mp3, mp4

- 2D/3D graphics loading and viewing without plug-ins

Enterprise class systems integration

- LDAP integration
- Single sign-on (customer specific customization)
- Compatible with Oracle J2EE
- Various APIs for interfacing with external systems such as ERP, diagnostic and parts management
- Integrations with PTC® Performance Advisor for system usage and monitoring

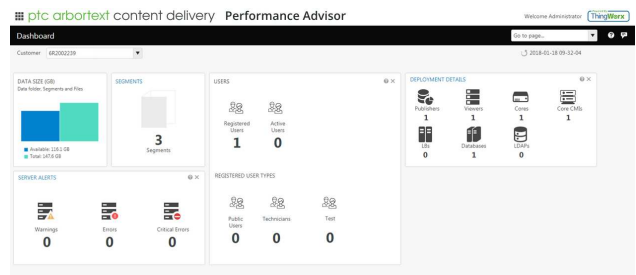

System monitoring using the Performance Advisor

Value of PTC Arbortext Content Delivery for Service Content

Often, the technical information needed to complete a task, particularly an unplanned repair, is spread across multiple documents and databases and must be pulled together manually. This leads to errors, delays, and wasted effort, with multiple trips back to the depot for parts, tools and service information. All these factors reduce maintenance efficiency, which increases downtime and decreases profits.

PTC Arbortext Content Delivery solves that industry problem by providing the Service technicians and equipment operators access to updated, configuration-specific, service information for their task at hand. Precision search, navigation and filtration pinpoint the user to the necessary high-quality information, boosting technician productivity and increasing field efficiencies.

Key benefits

Reduces content delivery cycle by:

- Aggregating multiple sources of content into a single delivery platform via PTC Windchill® Service Information Manager™
- Scalable CSV loader for third-party content loading
- Scalability via clustered servers supporting 24/7 uptime with no-downtime when performing content updates
- Efficient incremental processing of service content

Improves time user efficiency by:

- Increasing service accuracy by dynamically filtering the content for the users
- Shortening repair and maintenance resolution time
- Access and synchronize your content while connected or offline

Features

Dynamically delivers service technical documents information across a comprehensive range of formats

- Supporting DITA XML formats and others
- Interactive parts lists
- Product as configured
- Service procedures
- Operating instructions
- Bulletins
- Schematics
- Animations
- Maintenance guidelines

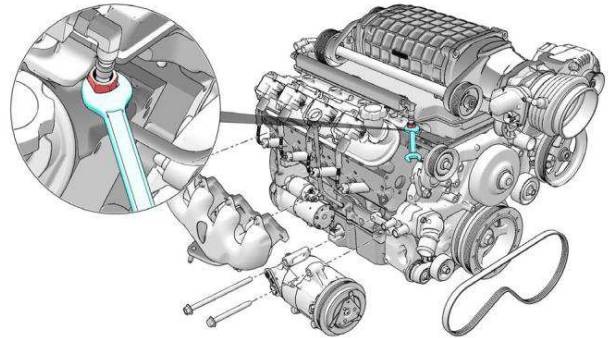

2D/3D graphical supplementation of procedural information

Supports online and offline/disconnected modes

- Single source multiple delivery channels
- Single source multiple delivery channels

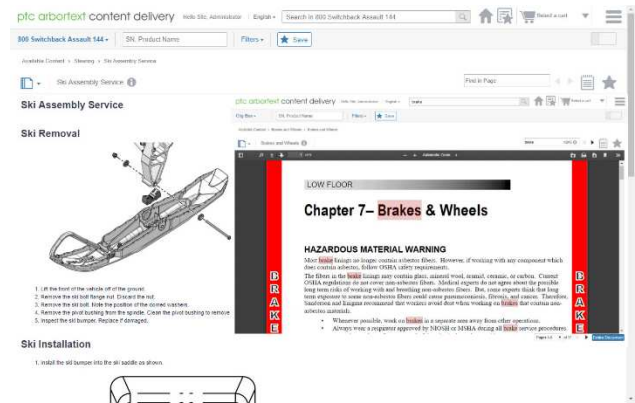

Value of PTC Arbortext Content Delivery for Service Parts

Often, the parts information required for completing a product specific repair task is hard to locate, inaccurate and outdated. This leads to errors, delays, and wasted effort, with multiple trips back to the depot for parts, tools and service information. All these factors leads to reduce maintenance efficiency, increases downtime and decreases execution time, customers satisfaction, and profits.

PTC Arbortext Content Delivery solves that industry problem by providing relevant, accurate product specific spare parts catalog to mechanics and technicians, which when linked with service content increases productivity through faster, more consistent and efficient execution of unplanned or planned maintenance jobs. This boosts first time fix rates (FTFR), reduces manpower requirements and

downtime cost, improves safety and compliance, improves mean-time-to-repair (MTTR), and increases customer satisfaction, without compromising on quality

Key benefits

Improves fix efficiency by:

- Product specific parts look-up
- Increasing service parts accuracy
- Shortening repair and maintenance resolution time
- Precisely relating and filtering service and parts information
- Delivering dynamic, interactive 3D and 2D illustrations that improve parts identification
- Visual indication of parts added to cart
- Seamless link to related service content

Improves service parts revenue by:

- Optimizing revenue through easy to use parts catalog
- Shopping cart integrations with ERP for Parts pricing, parts availability and shopping cart submission
- Related parts options: Recommended, Alternative, Superseded, Cross-Reference parts

End-2-End solution from publishing to delivery of service parts content

- Content publishing module integrated with PTC Windchill® Service Parts™
- Scalable CSV loader for third-party content loading

Quick and accurate service parts identification and ordering

- Easily create and manage your shopping carts or wish-lists in the shopping center
- View real-time price and availability
- Illustration and parts-list interactive linking

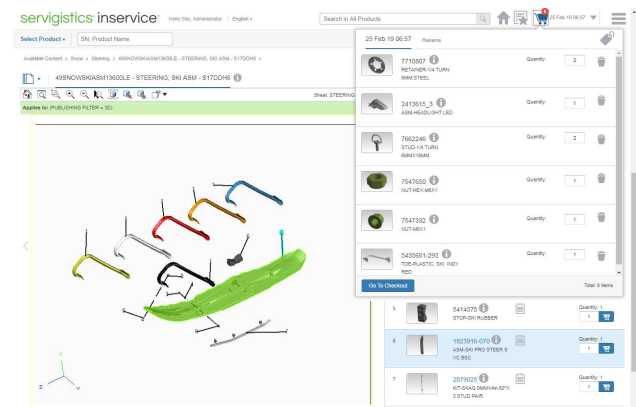

Learn More

For more information about Arbortext Content Delivery and the entire portfolio of Arbortext software products, visit: www.ptc.com/go/arbortext

© 2019, PTC Inc. (PTC). All rights reserved. Information described herein is furnished for informational use only, is subject to change without notice, and should not be taken as a guarantee, commitment, condition or offer by PTC. PTC, the PTC logo, Product & Service Advantage, Creo, Elements/Direct, Windchill, Mathcad and all other PTC product names and logos are trademarks or registered trademarks of PTC and/or its subsidiaries in the United States and other countries. All other product or company names are property of their respective owners. The timing of any product release, including any features or functionality, is subject to change at PTC's discretion.